

# COMPUTHERM T70

## Programmable wireless (radio-frequency) digital room thermostat



Instruction Manual

direct sunlight, refrigerator, chimney, etc). Do not use in wet, chemically aggressive or dusty environment. Its optimal location is 0.75 - 1.5 m above floor level.

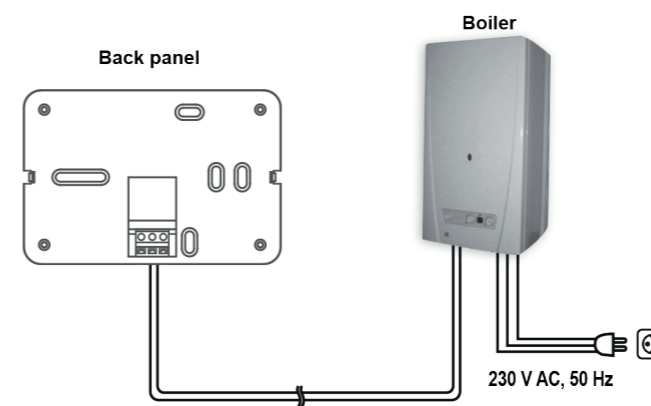
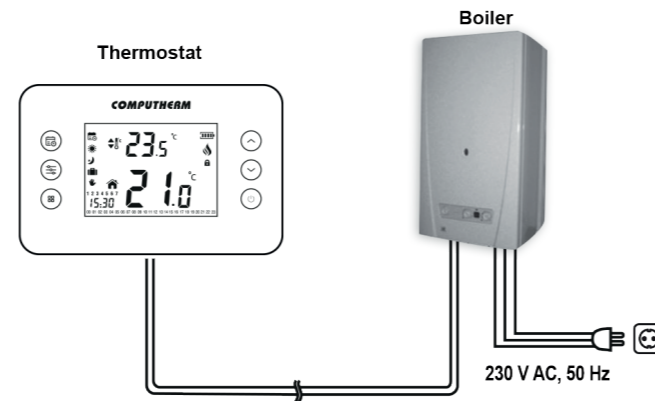

**ATTENTION!** Always consider the loadability of the thermostat and follow the manufacturer's instructions of the heating or cooling equipment. The device must be installed and connected by a qualified professional. The voltage appearing at terminals **NO** and **COM** depends only on the system being controlled, therefore the dimensions of the wires are determined by the type of the device to be controlled. The length of the wire is of no significance.

### 2.2. Insert the batteries

To put the thermostat into operation you should perform the following steps:

1. Detach the battery compartment cover.
2. According to the indicated polarities install the two AAA Micro Alkaline Batteries (LR03 type) provided in the box of the product into the battery holders.
3. Replace the battery compartment cover and mount the

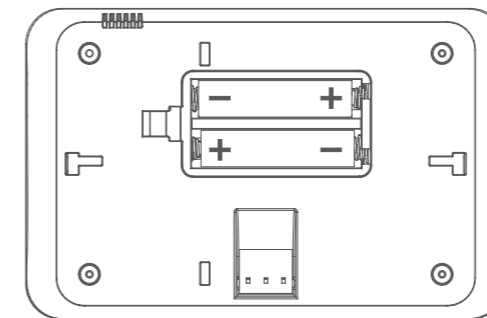

thermostat onto its wall-mounted supporting bracket.



4. To switch ON the thermostat press once the button located on the front panel.

**Warning!** Alkaline batteries may only be used for this appliance. Carbon-zinc batteries known as durable or long life batteries and chargeable accumulators are not suitable for the operation of this appliance. The  icon appearing on the display to indicate low battery voltage warns reliably that the batteries should be replaced only when alkaline batteries are used.

**Attention!** After the batteries have been replaced the exact time and day should be readjusted as described in **Chapter 2.4.** but the apparatus will memorize the other settings.

### 2.3. Operation of the key lock









**Attention!** The thermostat has an automatic key lock function to prevent accidental modifications of settings!





The  icon located on the right side of the display indicates that the key lock is turned on. To turn off the key lock, touch the  button for 3 seconds and the  icon disappears. Now





you can freely use the touch keys of the thermostat until the automatic key lock is activated again. The key lock turns on 10 seconds after the last key has been touched, indicated by the appearance of the  icon on the display.





### 2.4. Setting the current day, exact time and temperatures used during the operation

Touch the  button for 3 seconds. Only the set time can be seen on the display of the thermostat, where the first two digits showing the hour are flashing and the digits of the minute are continuously visible.

Using the  and  buttons, adjust the exact hour then touch the  button. Now the minute digits being set are flashing and the two digits indicating the hour are continuously visible. Using the  and  buttons, set the current minute value. Touch the  button again. Then the number indicating the set date appears on the display. Using the  and  buttons, set the current day (Monday: **1**; Tuesday: **2**; Wednesday: **3**, etc.).







Touch the  button again. Now the  icon appears on the display with the set temperature next to it, which means the Comfort temperature. This temperature can be modified by touching the  and  buttons.

Touch the  button again. Now the  icon appears on the display with the set temperature next to it, which means the Economy temperature. This temperature can be modified by touching the  and  buttons.

Touch the  button again. Now the  icon appears on the display with the set temperature next to it, which means the Absence temperature. This temperature can be modified by touching the  and  buttons.

If you want to finish settings, confirm them by touching  button for 3 seconds or wait for 10 seconds. Then set data are recorded and the display of the apparatus returns to the main screen.

### 2.5. Calibrating the thermometer of the thermostat

You can calibrate the thermometer of the appliance (to correct measured temperature). To enter the calibration menu, in the OFF state of the thermostat, press and hold the  button for 2 seconds. Then the thermostat enters the calibration menu, the sign „“ and the set calibration temperature appear on the display which shows  °C by default. Then you can set the required temperature by means of buttons  and  in the range between -8 °C and +8 °C, in 0.5 °C increments. Following this, to save the setting and exit wait 10 seconds or press the  button three times. Now the thermostat is OFF and the setting will be activated when the thermostat is turned on again.

### 2.6. Switch between heating and cooling modes

You have the possibility to easily switch between heating (factory setting) and cooling modes.

The output terminals **NO** and **COM** of the thermostat are closed below the set temperature in heating mode, and they are closed above the set temperature in cooling mode (taking the switching sensitivity into account). The closed position of the **NO** and **COM** connection points of the output relay is indicated by the appearance of the  icon in the display of the apparatus both in heating and cooling modes.

**IMPORTANT WARNING!** If the radiator valves in your flat are equipped with a thermostatic head, adjust it to maximum temperature or replace the thermostatic head of the radiator valve with a manual control knob in the room where the room thermostat is to be located, otherwise the thermostatic head may disturb the temperature control of the flat.

### 2. INSTALLATION OF THE THERMOSTAT

**WARNING! The device must be installed and connected by a qualified professional! Before installing, make sure that that neither the thermostat nor the device to be controlled is connected to the 230 V mains voltage. Modifying the thermostat can cause electric shock or product failure.**

#### 2.1. To install and connect the thermostat you should perform the following steps:

1. Detach the back panel of the thermostat from the front panel as shown in the figure below.

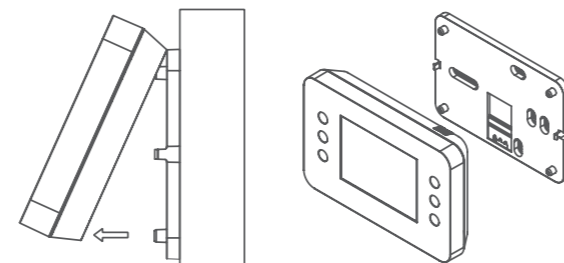

2. Secure the back panel of the device on the wall using the supplied mounting screws. Make sure that the arrows on the back panel are pointing upward.
3. The thermostat controls the boiler or air conditioner through a potential-free alternating relay that has the following connection points: **NO** and **COM**. These connection points are on the thermostat wall plate.
4. Connect the two connection points of the heating or cooling equipment to be controlled to the normally open **NO** and **COM** terminals of the relay.

If you would like to operate an old boiler or any other device that has no connection points for thermostats, then the **NO** and **COM** connection points of the thermostat should be connected to the mains cable of the device, similarly as a switch would be connected.

### GENERAL DESCRIPTION OF THE THERMOSTAT

The **COMPUTHERM T70** type switched-mode room thermostat is suitable to regulate the overwhelming majority of boilers and air conditioners available in Hungary. It can be easily connected to any gas boiler having a two-wire thermostat connection point and to any air conditioning apparatus or electrical apparatus, regardless of whether they have a 24 V or 230 V control circuit.



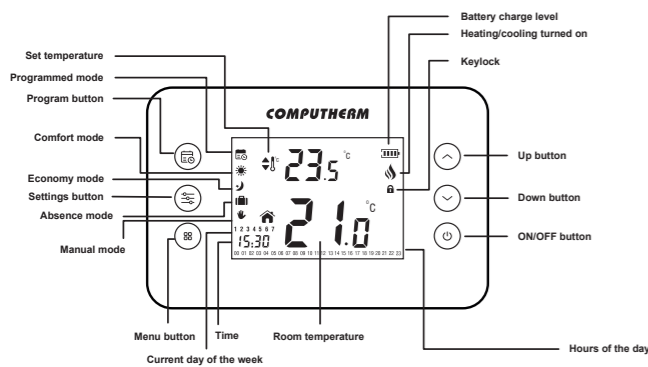







The thermostat can be programmed according to specific needs so that the heating (cooling) system heats (cools) your home or office to the desired temperature at the specified times specified, and it contributes to the reduction of energy costs, in addition to providing comfort. A daily temperature program can be prepared for each day of the week, independently of each other. It is possible to set comfort or economy temperature for each hour of the day separately.



The simultaneous use of several **COMPUTHERM** room thermostats and one **COMPUTHERM Q4Z** zone controller provides the possibility for the thermostats to also control a pump or a zone valve in addition to starting the heater or cooler. This way it is easy to divide a heating / cooling system into zones, thanks to which the heating / cooling of each room can be controlled separately, thus greatly increasing comfort. Furthermore, the zoning of the heating / cooling system will greatly contribute to the reduction of energy costs, as due to this only those rooms will be heated / cooled at any time where it is required.

### 1. LOCATION OF THE DEVICE







It is reasonable to locate it in a room used regularly or for many hours per day so that it is in the direction of natural ventilation in the room but protected from drought or extreme heat (e.g.



To enter the switching mode menu, in the  state of the thermostat, press and hold the  button for 2 seconds. Then the thermostat enters the calibration menu, the sign „“ and the set calibration temperature appear on the display. Now press the  button. Then the thermostat enters the menu used to switch between heating and cooling modes and signs „“ and „“ (factory setting) appear on the display. You can switch between heating () and cooling () modes by using  and  buttons. Following this, to save the setting and exit wait 10 seconds or press the  button two times. Now the thermostat is OFF and the setting will be activated when the thermostat is turned on again.

### 3. OPERATING MODES OF THE THERMOSTAT





The thermostat can be used in 5 different modes which satisfy customers' needs.

#### Selectable modes

- Programmed mode** (): controls heating/cooling according to the preset program
- Comfort mode** (): heats/cool your home continuously to the preset comfort temperature
- Economy mode** (): heats/cool your home continuously to the preset economy temperature
- Absence mode** (): heats/cool your home continuously to the preset absence/vacation temperature
- Manual mode** (): controls the heating/cooling system always according to the actual temperature set by the  and  buttons.

You can switch between modes by touching the  button. The manual mode can be activated in any operating mode, by touching the  or  buttons.

### 4. OPERATION OF THE INSTALLED THERMOSTAT

With the temperature adjustment buttons ( or ) of the thermostat you can set the desired temperature between 5 °C and 30 °C in 0.5 °C increments. The thermostat controls the device connected to it (e.g. gas boiler or pump) based on the measured and the currently set temperature, taking the switching sensitivity of the thermostat into account. This means that if the thermostat is in heating mode and set to 22 °C, then with the ±0.2 °C switching sensitivity the connection points **NO** and **COM** of the output relay are closed below 21.8 °C (heating is turned on) and opened at temperatures above 22.2 °C (heating is turned off). In cooling mode, the relay switches exactly the opposite way. On the other hand, after the temperature has been modified by the temperature adjustment buttons ( or ) of the thermostat the switching sensitivity is not taken into account therefore the thermostat will switch (turn off the heating) in case of ±0.1 °C temperature difference.

Depending on the change in the room and set temperature the thermostat controls (turns on or off) the heating/cooling system connected thereto. By default, the **NO** and **COM** contact pairs of the relay are open. The closed position of the **NO** and **COM** connection points of the output relay is indicated by the appearance of the  icon on the display of the apparatus both in heating and cooling modes.







### 5. PROGRAMMING THE THERMOSTAT

#### 5.1. A brief introduction to programming

Programming means setting of switching times and the selection of temperature values (Comfort, Economy) assigned to them. The apparatus can be programmed for a period of one week. Its operation is automatic, repeating the preset switching process cyclically every seven days. The thermostat can be programmed for each hour of every day of the week separately, independently of each other. The preset Comfort or Economy temperature can be selected for each switching time. The temperature set for a given hour will remain valid until the start of the next hour, i.e. on a given day the temperature set for 11:00 a.m. will be maintained until noon, and the temperature set for noon will be maintained until 1:00 p.m. and so on.

**Remark:** Otherwise, from both a comfort and an energy-efficiency point of view, it is recommended to activate more than one switch for each day. Furthermore, it is advised that a comfort temperature is used only those times, when the room or building is in use, since every 1 °C decrease of temperature saves approximately 6% energy during a heating season.



#### 5.2. Programming steps

- To enter programming mode touch the  button for 3 seconds. During the programming process the values to be set (day, hour, Comfort/Economy temperature) appear on the display of the apparatus.
- The **Comfort or Economy** temperature set beforehand can be assigned to every hour. Touching the  button you can switch between the two temperatures belonging to the hour concerned.
- By means of  and  buttons you can jog between hours within a given day. The actual hour appears, flashing at the bottom of the display. When jogging between hours the (**Comfort or Economy**) temperature selected for the hour being set will be saved. At the bottom of the display those hour numbers are indicated to which **Comfort** temperature is assigned, in case of **Economy** temperature the number of the hour concerned disappears after moving on.
- After preparing the entire program for a day you can set the next day after touching the  button or by touching the  button after the adjustment has been completed for 11:00 p.m.
- After you have prepared the program for every day according to your needs and you wish to finish programming, confirm the settings by touching the  button for 3 seconds. Then set data are recorded and the display of the apparatus returns to the main screen.

#### 5.3. Recommendations for creating a heating program

The average comfort needs of a person can usually be satisfied by a temperature of 19-21 °C during the night, and a temperature of 22-23 °C during the day. During that time of the day, when the family is at work or school, only a lower temperature is needed. As heating up and cooling down usually takes a long time, it is reasonable to set the start time of the switches 0.5-1 hour before the desired time of the modified temperature. The programmability of the thermostat provides a perfect solution for this.







### 6. BATTERY REPLACEMENT

The average lifetime of the batteries is 1 year. The thermostat indicates battery charge level (e.g. ) on its display. The batteries should be replaced when the battery level icon on the display of the thermostat shows low charge level (). To replace the batteries, disconnect the thermostat from the wall mount bracket, then detach the battery cover. Insert 2 AAA **micro alkaline batteries** (LR03 type) in accordance with the diagram in the battery compartment. After the batteries have been replaced the temperature value should be readjusted because the apparatus returns to factory settings.

**Warning! Alkaline batteries may only be used for this appliance.** Carbon-zinc batteries known as durable or long life batteries and chargeable accumulators are not suitable for the operation of this appliance. The  icon appearing on the display to indicate low battery voltage warns reliably that the batteries should be replaced only when alkaline batteries are used.

### 7. RESETING THE THERMOSTAT TO ITS FACTORY DEFAULT SETTINGS

You can return all settings of the apparatus (set temperature [Comfort, Economy, Absence, Manual], set time, set date, weekly programming and calibration of thermostat) to their defaults.

To restore factory settings press the  button for 2 seconds in the OFF state of the thermostat. Then the thermostat enters the calibration menu, the sign „“ and the set calibration temperature appear on the display which shows  °C by default. Now press the  button twice. Then the thermostat enters the factory reset menu and the „“ sign appears on the display. To reset the thermostat to factory settings press the  button for 3 seconds. The thermostat switches off and its settings they are reset to factory defaults.

If you do not wish to restore factory settings wait 10 seconds or press the  button and the thermostat turns OFF. After the factory setting has been restored, perform base settings and programming of the apparatus as described in **Chapters 2 and 5**.

### FREQUENTLY ASKED QUESTIONS

When you think that your appliance is operating incorrectly or encounter any problem while the appliance is being used then we recommend that you read Frequently Asked Questions (FAQ) available on our website, where we collected the problems and questions that most frequently occur while our appliances are being used, along with the solutions thereto:

<http://www.computherm.info/en/faq>



The vast majority of the problems encountered can be solved easily by using the hints available on our website, without seeking professional help. If you have not found a solution to your problem, please pay a visit to our qualified service.

**Warning! The manufacturer does not assume responsibility for any direct or indirect damages and loss of income occurring while the appliance is being used.**

### PRODUCT INFORMATION DATA SHEET:

- Trademark: **COMPUTHERM**
- Model identifier: **T70**
- Temperature control class: **I. class**
- Contribution to the efficiency of seasonal space heating: **1%**

#### Remark:

In addition to using modern temperature regulators, the following up-to-date regulation methods also contribute significantly to the improvement of the comfort provided by the heating network, the energy efficiency of the heating network and the coefficient of performance:

- By dividing the heating network into sections or zones (e.g. by means of **COMPUTHERM Q4Z** zone controller and the associated **COMPUTHERM** zone valves) and with their separate regulation we can ensure that every room (zone) is heated only when it is necessary. (You can obtain information on the establishment of the heating network and apparatuses and fittings needed for division into zones in our publication titled „Energy Savings and Comfort“ which is also available on our website [www.computherm.info/en](http://www.computherm.info/en)).
- Using programmable thermostats you can ensure that every room (zone) is just heated according to a timetable preset in accordance with the demands. (You can obtain information on the services provided by **COMPUTHERM** programmable room thermostats on our website).
- Using modern modular heating devices equipped with an external temperature sensor the boiler can be operated at a higher efficiency.
- Using low temperature heating networks (e.g. 60/40 °C) and condensing boilers the temperature of the flue gas leaving the boiler can be reduced, and this way fuel efficiency can be improved significantly.

### TECHNICAL DATA

— temperature measurement range:	-9.9 °C to +50 °C (in 0.1 °C increments)
— adjustable temperature range:	+5 °C to +30 °C (in 0.5 °C increments)
— temperature measurement accuracy:	±0.5 °C
— temperature calibration range:	±8.0 °C (in 0.5 °C increments)
— switching sensitivity:	±0.2 °C
— battery voltage:	2 x 1.5 V ALKALINE batteries (LR03 type; AAA size)
— switchable voltage:	max. 30 V DC / 250 V AC
— switchable current:	8 A (2 A inductive load)
— battery lifetime:	approx. 1 year
— protection against environmental impacts:	IP20
— dimensions:	136 x 88 x 25 mm (without holder)
— weight:	182 g
— temperature sensor type:	NTC 3950 K 10 kΩ ±1% at 25 °C
— storage temperature:	-20 °C to +60 °C

The **COMPUTHERM T70** type thermostat complies with the requirements of directives EMC 2014/30/EU, LVD 2014/35/EU and RoHS 2011/65/EU.



**Manufacturer:** **QUANTRAX Ltd.**  
H-6726, Szeged, Fülemlé u. 34., Hungary  
Phone: +36 62 424 133  
Fax: +36 62 424 672  
E-mail: [iroda@quantrax.hu](mailto:iroda@quantrax.hu)  
Web: [www.quantrax.hu](http://www.quantrax.hu) • [www.computherm.info](http://www.computherm.info)

**Origin:** Turkey